

# 2025香港英式桌球公開賽 - 第一站

## Hong Kong Snooker Open Championship 2025 - Event 1

比賽場地 Venue : 名智桌球(觀塘) Ming's Snooker (Kwun Tong)

地址 : 九龍觀塘興業街4號The Wave 5樓 電話 : 3615 8601

Address : 5/F, The Wave, No. 4 Hing Yip Street, Kwun Tong, Kolwoon. Phone : 3615 8601

名智觀塘 1

### 出線64強

### 出線64強

### 出線64強

### 出線64強

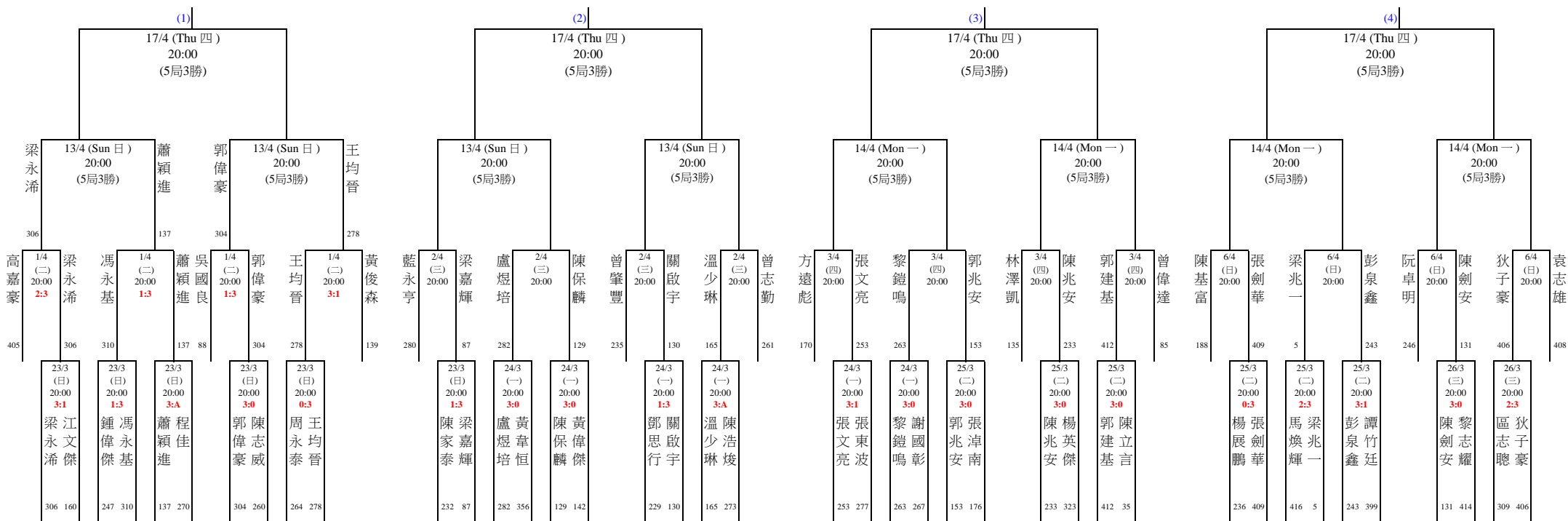

網頁Web-site : <http://www.hkbilliardsports.org.hk/>

**註 Remarks :**

- (1) 賽事採用單淘汰制：初賽 - 5局3勝；64強至八強及季軍賽 - 7局4勝；四強及決賽 - 9局5勝。  
Knock-Out System: Preliminary - Best of 5 Frames; Last 64 to Quarter Finals, including the 2nd Runner-up Match - Best of 7 Frames; Semi Finals & Final - Best of 9 Frames.
- (2) 參賽者遲於開賽時間到達比賽場地報到則負一局；再遲於指定時間15分鐘到達比賽場地報到作棄權論，報名費概不發還。  
Any player who is late for reporting will lose 1 frame and if late for 15 minutes will lose the Match and entry fee will be forfeited.
- (3) 參賽者必須穿著整齊服裝（長褲、恤衫/T-恤及皮鞋/波鞋；64強至總決賽：長袖純色恤衫、長西褲、背心、愛夾、深色皮鞋及襪），否則不准出賽。  
Player must wear properly (trousers, shirt/T-shirt and leather shoes/ sport shoes). Tournament standard dress is required from Last 64: Long sleeve predominately plain coloured shirts buttoned at the wrist, trousers, waistcoat, bow tie, dark leather shoes and socks must be worn.
- (4) 場館負責登記一棒最高度數記錄。Officials of venue will record the highest break of each match.  
如有任何查詢，請致電中國香港桌球總會有限公司（賽事總監陳順佳先生 電話：9488 4541 總裁判陳榮志先生 電話：9435 1069）  
Enquiry : HKBSCC (Mr. Jerry Chan - Tournament Director : 9488 4541 Mr. Chan Wing Chung - Chief Referee :9435 1069)

**參加者必須穿著指定服裝，否則不准出賽。**

# 2025香港英式桌球公開賽 - 第一站

## Hong Kong Snooker Open Championship 2025 - Event 1

比賽場地 Venue : 名智桌球(觀塘) Ming's Snooker (Kwun Tong)

地址 : 九龍觀塘興業街4號The Wave 5樓 電話 : 3615 8601

Address : 5/F, The Wave, No. 4 Hing Yip Street, Kwun Tong, Kolwoon. Phone : 3615 8601

名智觀塘 2

### 出線64強

### 出線64強

### 出線64強

### 出線64強

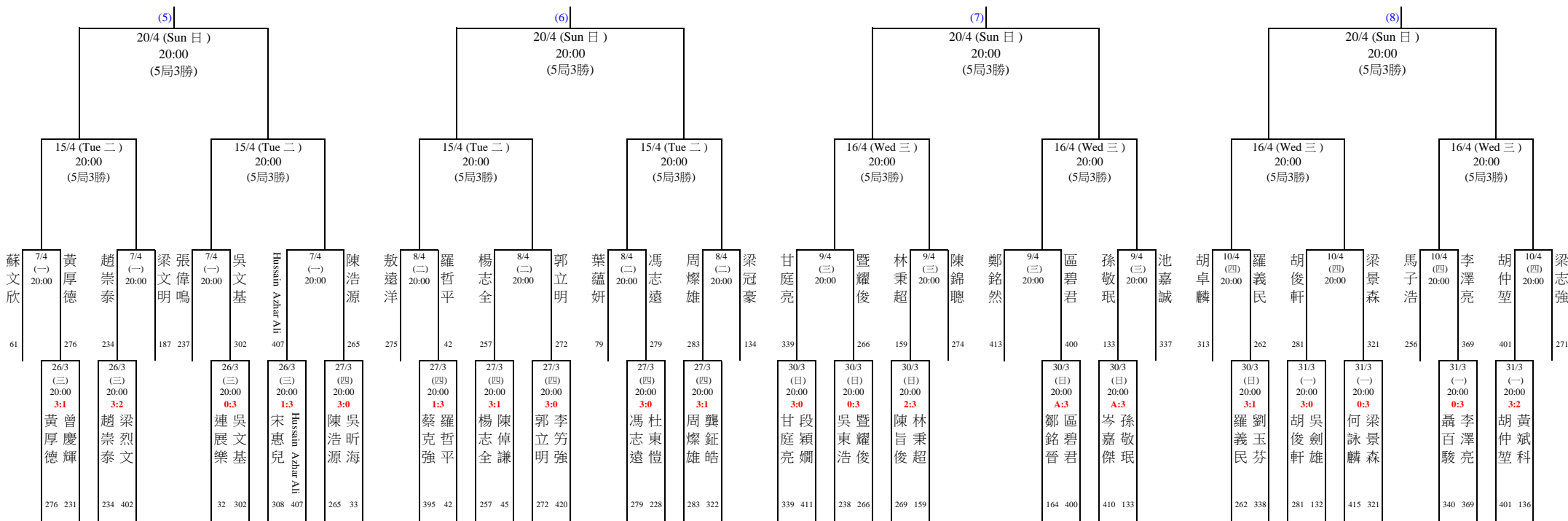

網頁Web-site : <http://www.hkbilliardsports.org.hk/>

#### 註 Remarks :

- 賽事採用單淘汰制：初賽 - 5局3勝；64強至八強及季軍賽 - 7局4勝；四強及決賽 - 9局5勝。  
Knock-Out System: Preliminary - Best of 5 Frames; Last 64 to Quarter Finals, including the 2nd Runner-up Match - Best of 7 Frames; Semi Finals & Final - Best of 9 Frames.
- 參賽者遲於開賽時間到達比賽場地報到則負一局；再遲於指定時間15分鐘到達比賽場地報到作棄權論，報名費概不發還。  
Any player who is late for reporting will lose 1 frame and if late for 15 minutes will lose the Match and entry fee will be forfeited.
- 參賽者必須穿著整齊服裝（長褲、恤衫/T-恤及皮鞋/波鞋；64強至總決賽：長袖純色恤衫、長西褲、背心、煲呔、深色皮鞋及襪），否則不准出賽。  
Player must wear properly (trousers, shirt/T-shirt and leather shoes/ sport shoes). Tournament standard dress is required from Last 64: Long sleeve predominately plain coloured shirts buttoned at the wrist, trousers, waistcoat, bow tie, dark leather shoes and socks must be worn.
- 場館負責登記一棒最高度數記錄。Officials of venue will record the highest break of each match.  
如有任何查詢，請致電中國香港桌球總會有限公司（賽事總監陳順佳先生 電話：9488 4541 總裁判陳榮志先生 電話：9435 1069）  
Enquiry : HKBSCC (Mr. Jerry Chan - Tournament Director : 9488 4541 Mr. Chan Wing Chung - Chief Referee : 9435 1069)

參加者必須穿著指定服裝，否則不准出賽。

# 2025香港英式桌球公開賽 - 第一站

## Hong Kong Snooker Open Championship 2025 - Event 1

比賽場地 Venue : 名智桌球(觀塘) Ming's Snooker (Kwun Tong)

名智觀塘 3

地址 : 九龍觀塘興業街4號The Wave 5樓 電話 : 3615 8601

Address : 5/F, The Wave, No. 4 Hing Yip Street, Kwun Tong, Kolwoon. Phone : 3615 8601

出線8強

出線8強

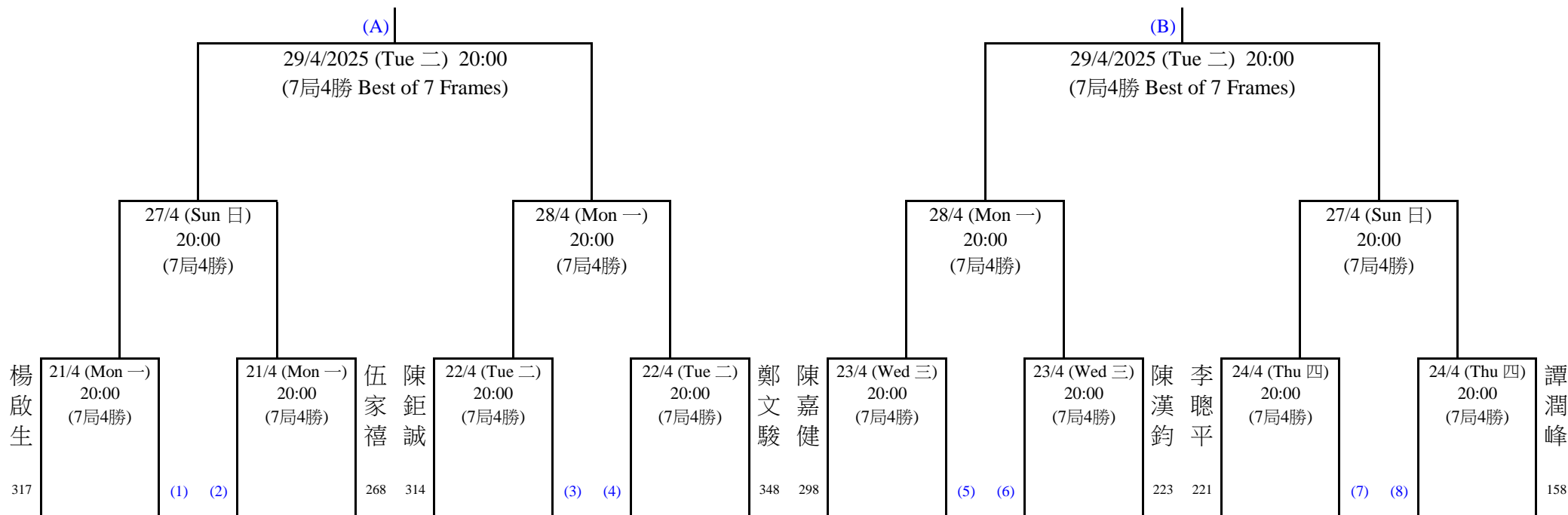

**註 Remarks :**

網頁Web-site : <http://www.hkbilliardsports.org.hk/>

- (1) 賽事採用單淘汰制：初賽 - 5局3勝；64強至八強及季軍賽 - 7局4勝；四強及決賽 - 9局5勝。  
Knock-Out System: Preliminary - Best of 5 Frames; Last 64 to Quarter Finals, including the 2nd Runner-up Match - Best of 7 Frames; Semi Finals & Final - Best of 9 Frames.
- (2) 參賽者遲於開賽時間到達比賽場館報到則負一局；再遲於指定時間15分鐘到達比賽場館報到作棄權論，報名費概不發還。  
Any player who is late for reporting will lose 1 frame and if late for 15 minutes will lose the Match and entry fee will be forfeited.
- (3) 參賽者必須穿著整齊服裝（長褲、恤衫/T-恤及皮鞋/波鞋；64強至總決賽：長袖純色恤衫、長西褲、背心、煲呔、深色皮鞋及襪），否則不准出賽。  
Player must wear properly (trousers, shirt/T-shirt and leather shoes/ sport shoes). Tournament standard dress is required from Last 64: Long sleeve predominately plain coloured shirts buttoned at the wrist, trousers, waistcoat, bow tie, dark leather shoes and socks must be worn.
- (4) 場館負責登記一棒最高度數記錄。Officials of venue will record the highest break of each match.

如有任何查詢，請致電中國香港桌球總會有限公司（賽事總監陳順佳先生 電話：9488 4541 總裁判陳榮忠先生 電話：9435 1069）  
Enquiry : HKBSCC (Mr. Jerry Chan - Tournament Director : 9488 4541 Mr. Chan Wing Chung - Chief Referee : 9435 1069)

參加者必須穿著  
指定服裝，否則  
不准出賽。

# 2025香港英式桌球公開賽 - 第一站

## Hong Kong Snooker Open Championship 2025 - Event 1

比賽場地 Venue : 名智桌球(尖沙咀) Ming's Snooker (Tsim Sha Tsui)

修正版  
Revised

名智尖沙咀 1

地址 : 九龍尖沙咀寶勒巷6-8A號盈豐商業大廈地庫 電話 : 2845 1866

Address : Basement, Winfield Commercial Building, 6-8A Prat Avenue, Tsim Sha Tsui, Kowloon. Phone : 2153 0228

### 出線64強

### 出線64強

### 出線64強

### 出線64強

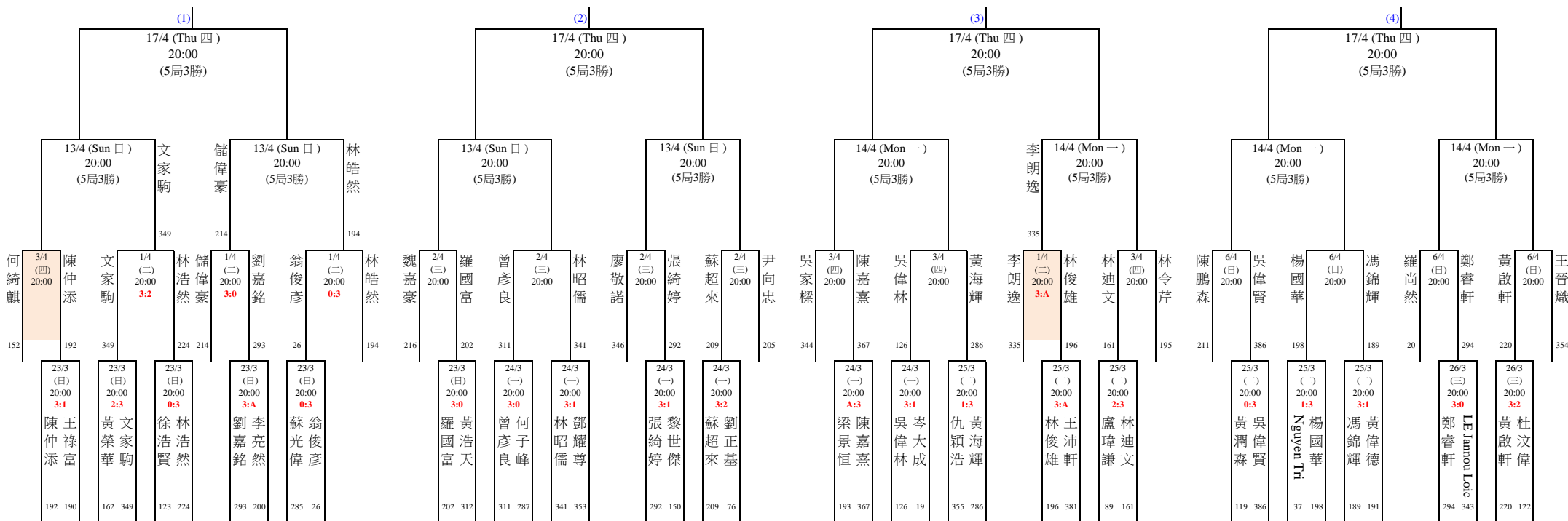

網頁Web-site : <http://www.hkbilliardsports.org.hk/>

**註 Remarks :**

- 賽事採用單淘汰制：初賽 - 5局3勝；64強至八強及季軍賽 - 7局4勝；四強及決賽 - 9局5勝。  
Knock-Out System: Preliminary - Best of 5 Frames; Last 64 to Quarter Finals, including the 2nd Runner-up Match - Best of 7 Frames; Semi Finals & Final - Best of 9 Frames.
- 參賽者遲於開賽時間到達比賽場地則負一局；再遲於指定時間15分鐘到達比賽場地則作棄權論，報名費概不發還。  
Any player who is late for reporting will lose 1 frame and if late for 15 minutes will lose the Match and entry fee will be forfeited.
- 參賽者必須穿著整齊服裝（長褲、恤衫/T-恤及皮鞋/波鞋；64強至總決賽：長袖純色恤衫、長西褲、背心、愛吹、深色皮鞋及襪），否則不准出賽。  
Player must wear properly (trousers, shirt/T-shirt and leather shoes/ sport shoes). Tournament standard dress is required from Last 64: Long sleeve predominately plain coloured shirts buttoned at the wrist, trousers, waistcoat, bow tie, dark leather shoes and socks must be worn.
- 場館負責登記一棒最高度數紀錄。Officials of venue will record the highest break of each match.  
如有任何查詢，請致電中國香港桌球總會有限公司（賽事總監陳順佳先生 電話：9488 4541 總裁判陳榮志先生 電話：9435 1069）  
Enquiry : HKBSCC (Mr. Jerry Chan - Tournament Director : 9488 4541 Mr. Chan Wing Chung - Chief Referee : 9435 1069)

參加者必須穿著指定  
服裝，否則不准出賽。

# 2025香港英式桌球公開賽 - 第一站

## Hong Kong Snooker Open Championship 2025 - Event 1

比賽場地 Venue : 名智桌球(尖沙咀) Ming's Snooker (Tsim Sha Tsui)

名智尖沙咀 2

地址 : 九龍尖沙咀寶勒巷6-8A號盈豐商業大廈地庫      電話 : 2845 1866  
Address : Basement, Winfield Commercial Building, 6-8A Prat Avenue, Tsim Sha Tsui, Kowloon.      Phone : 2153 0228

### 出線64強

### 出線64強

### 出線64強

### 出線64強

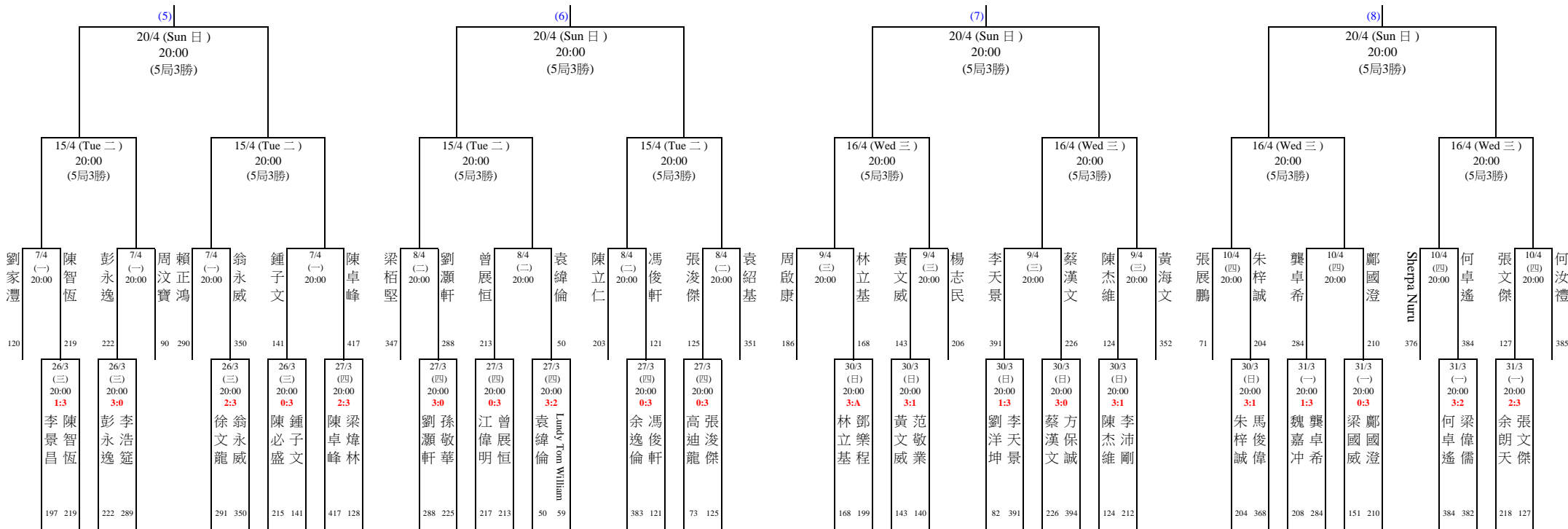

網頁Web-site : <http://www.hkbilliardsports.org.hk/>

#### 註 Remarks :

- 賽事採用單淘汰制：初賽 - 5局3勝；64強至八強及季軍賽 - 7局4勝；四強及決賽 - 9局5勝。  
Knock-Out System: Preliminary - Best of 5 Frames; Last 64 to Quarter Finals, including the 2nd Runner-up Match - Best of 7 Frames; Semi Finals & Final - Best of 9 Frames.
- 參賽者遲於開賽時間到達比賽場地報到則負一局；再遲於指定時間15分鐘到達比賽場地報到作棄權論，報名費概不發還。  
Any player who is late for reporting will lose 1 frame and if late for 15 minutes will lose the Match and entrv fee will be forfeited.
- 參賽者必須穿著整齊服裝（長褲、恤衫/T-恤及皮鞋/波鞋；64強至總決賽：長袖純色恤衫、長西褲、背心、煲呔、深色皮鞋及襪），否則不准出賽。  
Player must wear properly (trousers, shirt/T-shirt and leather shoes/ sport shoes). Tournament standard dress is required from Last 64: Long sleeve predominately plain coloured shirts buttoned at the wrist, trousers, waistcoat, bow tie, dark leather shoes and socks must be worn.
- 場館負責登記一棒最高度數紀錄。Officials of venue will record the highest break of each match.  
如有任何查詢，請致電中國香港桌球總會有限公司（賽事總監陳順佳先生 電話：9488 4541 總裁判陳榮忠先生 電話：9435 1069）  
Enquiry : HKBSCC (Mr. Jerry Chan - Tournament Director : 9488 4541 Mr. Chan Wing Chung - Chief Referee : 9435 1069)

參加者必須穿著指定  
服裝，否則不准出賽。

# 2025香港英式桌球公開賽 - 第一站

## Hong Kong Snooker Open Championship 2025 - Event 1

比賽場地 Venue : 名智桌球(尖沙咀) Ming's Snooker (Tsim Sha Tsui)

名智尖沙咀 3

地址：九龍尖沙咀寶勒巷6-8A號盈豐商業大廈地庫 電話：2845 1866

Address : Basement, Winfield Commercial Building, 6-8A Prater Avenue, Tsim Sha Tsui, Kowloon. Phone : 2153 0228

出線8強

出線8強

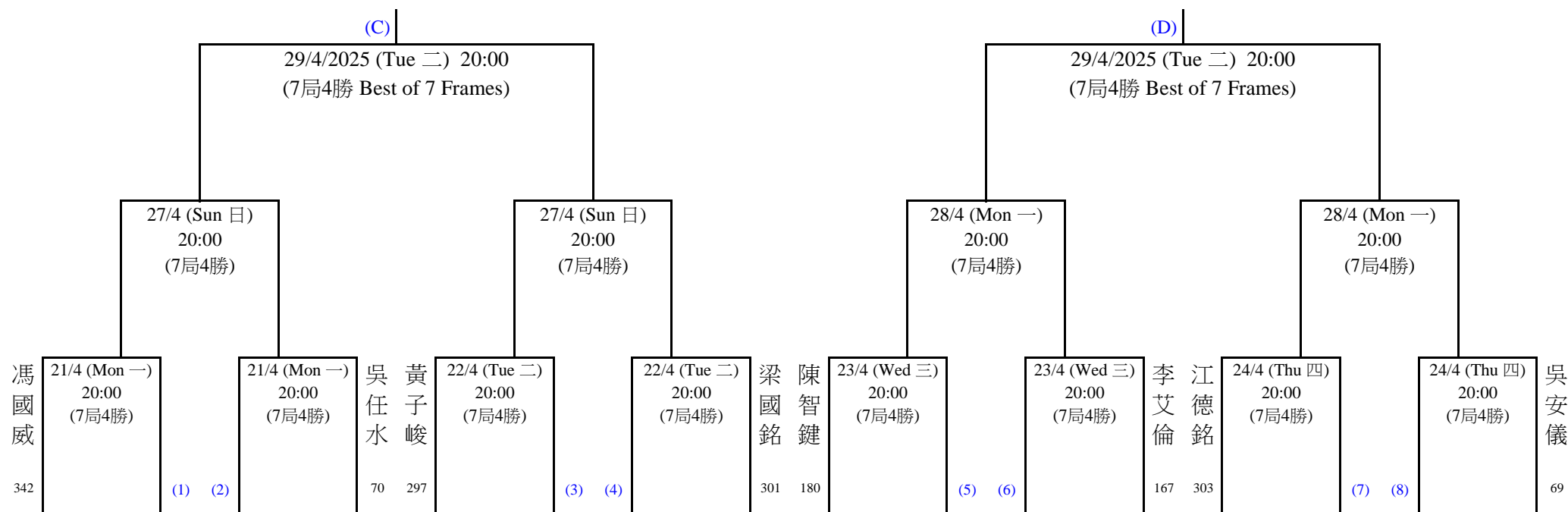

### 註 Remarks :

網頁Web-site : <http://www.hkbilliardsports.org.hk/>

- (1) 賽事採用單淘汰制：初賽 - 5局3勝；64強至八強及季軍賽 - 7局4勝；四強及決賽 - 9局5勝。  
Knock-Out System: Preliminary - Best of 5 Frames; Last 64 to Quarter Finals, including the 2nd Runner-up Match - Best of 7 Frames; Semi Finals & Final - Best of 9 Frames.
- (2) 參賽者遲於開賽時間到達比賽場館報到則負一局；再遲於指定時間15分鐘到達比賽場館報到作棄權論，報名費概不發還。  
**Any player who is late for reporting will lose 1 frame and if late for 15 minutes will lose the Match and entry fee will be forfeited.**
- (3) 參賽者必須穿著整齊服裝（長褲、恤衫/T-恤及皮鞋/波鞋；64強至總決賽：長袖純色恤衫、長西褲、背心、煲吹、深色皮鞋及襪），否則不准出賽。  
**Player must wear properly (trousers, shirt/T-shirt and leather shoes/ sport shoes). Tournament standard dress is required from Last 64: Long sleeve predominately plain coloured shirts buttoned at the wrist, trousers, waistcoat, bow tie, dark leather shoes and socks must be worn.**
- (4) 場館負責登記一棒最高度數記錄。Officials of venue will record the highest break of each match.

如有任何查詢，請致電中國香港桌球總會有限公司（賽事總監陳順佳先生 電話：9488 4541 總裁判陳榮忠先生 電話：9435 1069）

Enquiry : HKBSCC (Mr. Jerry Chan - Tournament Director : 9488 4541 Mr. Chan Wing Chung - Chief Referee :9435 1069)

參加者必須穿著  
指定服裝，否則  
不准出賽。

# 2025香港英式桌球公開賽 - 第一站

## Hong Kong Snooker Open Championship 2025 - Event 1

比賽場地 Venue : 名智桌球(柴灣) Ming's Snooker (Chai Wan)

名智柴灣 1

地址 : 香港柴灣柴灣道111號高威閣2樓1號(前座) 電話 : 2515 2833

Address : Flat 1 (Front Portion), 2/F, Koway Court, No. 111 Chai Wan Road, Chai Wan, Hong Kong. Phone : 2515 2833

### 出線64強

### 出線64強

### 出線64強

### 出線64強

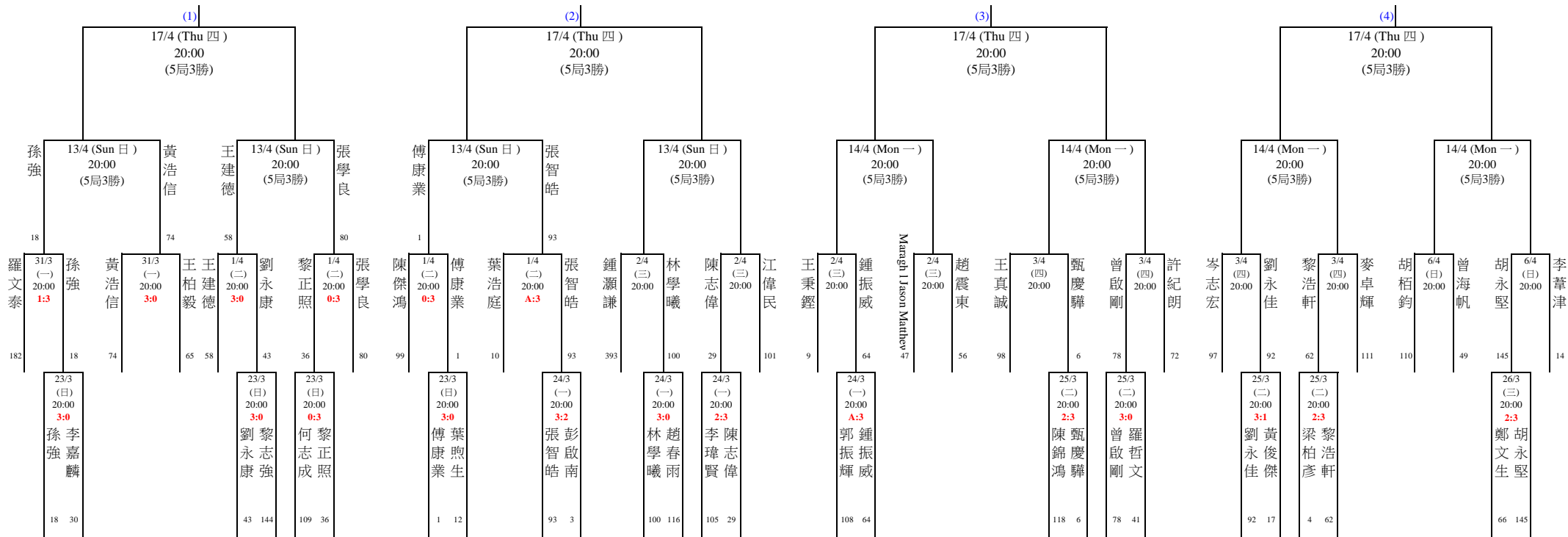

網頁Web-site : <http://www.hkbilliardsports.org.hk/>

**註 Remarks :**

- (1) 賽事採用單淘汰制：初賽 - 5局3勝；64強至八強及季軍賽 - 7局4勝；四強及決賽 - 9局5勝。  
Knock-Out System: Preliminary - Best of 5 Frames; Last 64 to Quarter Finals, including the 2nd Runner-up Match - Best of 7 Frames; Semi Finals & Final - Best of 9 Frames.
- (2) **參賽者遲於開賽時間到達比賽場地報到則負一局；再遲於指定時間15分鐘到達比賽場地報到作棄權論，報名費概不發還。**  
**Any player who is late for reporting will lose 1 frame and if late for 15 minutes will lose the Match and entry fee will be forfeited.**
- (3) **參賽者必須穿著整齊服裝（長褲、恤衫/T-恤及皮鞋/波鞋；64強至總決賽：長袖純色恤衫、長西褲、背心、雙呔、深色皮鞋及襪），否則不准出賽。**  
**Player must wear properly (trousers, shirt/T-shirt and leather shoes/ sport shoes). Tournament standard dress is required from Last 64: Long sleeve predominately plain coloured shirts buttoned at the wrist, trousers, waistcoat, bow tie, dark leather shoes and socks must be worn.**
- (4) 場館負責登記一棒最高度數記錄。Officials of venue will record the highest break of each match.  
如有任何查詢，請致電中國香港桌球總會有限公司（賽事總監陳順佳先生 電話：9488 4541 總裁判陳榮忠先生 電話：9435 1069）  
Enquiry : HKBSCC (Mr. Jerry Chan - Tournament Director : 9488 4541 Mr. Chan Wing Chung - Chief Referee :9435 1069)

參加者必須穿著指定服裝，否則不准出賽。

# 2025香港英式桌球公開賽 - 第一站

## Hong Kong Snooker Open Championship 2025 - Event 1

比賽場地 Venue : 名智桌球(柴灣) Ming's Snooker (Chai Wan)

地址 : 香港柴灣柴灣道111號高威閣2樓1號(前座) 電話 : 2515 2833

Address : Flat 1 (Front Portion), 2/F, Koway Court, No. 111 Chai Wan Road, Chai Wan, Hong Kong. Phone : 2515 2833

名智柴灣 2

### 出線64強

### 出線64強

### 出線64強

### 出線64強

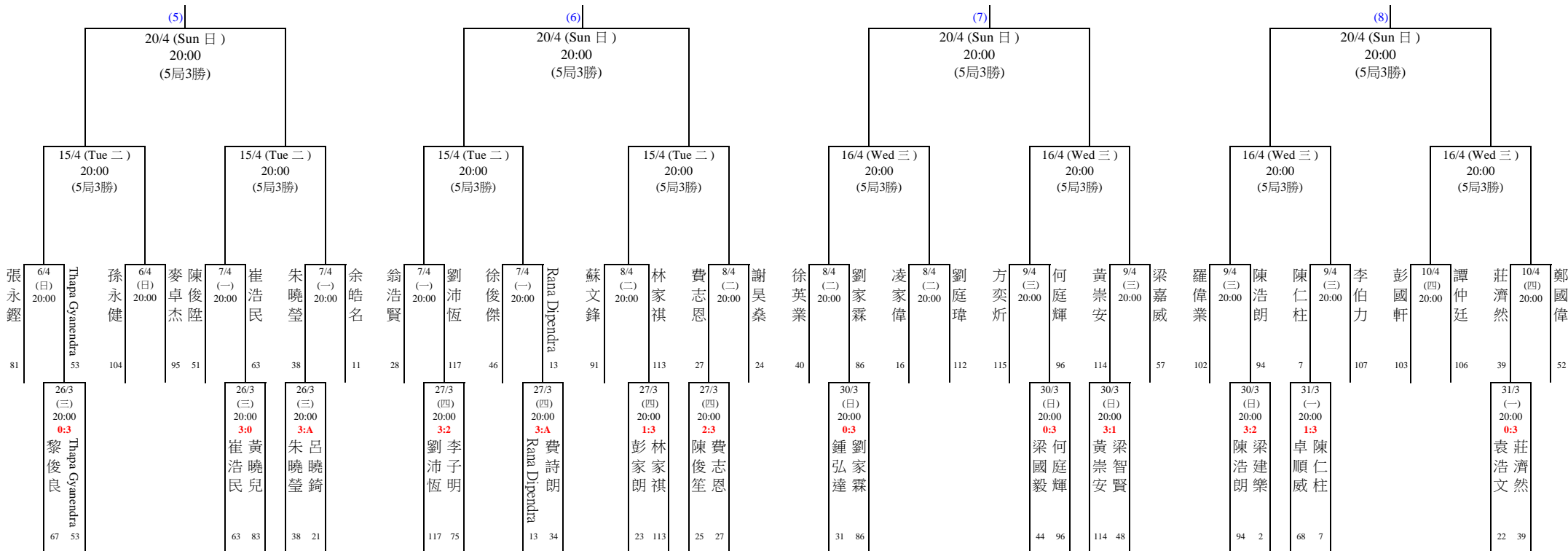

網頁Web-site : <http://www.hkbilliardsports.org.hk/>

#### 註 Remarks :

- 賽事採用單淘汰制：初賽 - 5局3勝；64強至八強及季軍賽 - 7局4勝；四強及決賽 - 9局5勝。  
Knock-Out System: Preliminary - Best of 5 Frames; Last 64 to Quarter Finals, including the 2nd Runner-up Match - Best of 7 Frames; Semi Finals & Final - Best of 9 Frames.
- 參賽者遲於開賽時間到達比賽場館報到則負一局；再遲於指定時間15分鐘到達比賽場館報到作棄權論，報名費概不發還。  
Any player who is late for reporting will lose 1 frame and if late for 15 minutes will lose the Match and entry fee will be forfeited.
- 參賽者必須穿著整齊服裝（長褲、恤衫/T-恤及皮鞋/波鞋；64強至總決賽：長袖純色恤衫、長西褲、背心、煲夾、深色皮鞋及襪），否則不准出賽。  
Player must wear properly (trousers, shirt/T-shirt and leather shoes/ sport shoes). Tournament standard dress is required from Last 64: Long sleeve predominately plain coloured shirts buttoned at the wrist, trousers, waistcoat, bow tie, dark leather shoes and socks must be worn.
- 場館負責登記一桿最高度數記錄。Officials of venue will record the highest break of each match.  
如有任何查詢，請致電中國香港桌球總會有限公司（賽事總監陳順佳先生 電話：9488 4541 總裁判陳榮忠先生 電話：9435 1069）  
Enquiry : HKBSCC (Mr. Jerry Chan - Tournament Director : 9488 4541 Mr. Chan Wing Chung - Chief Referee : 9435 1069)

參加者必須穿著指定服裝，否則不准出賽。



# 2025香港英式桌球公開賽 - 第一站

## Hong Kong Snooker Open Championship 2025 - Event 1

比賽場地 Venue : 名智桌球(柴灣) Ming's Snooker (Chai Wan)

名智柴灣 3

地址 : 香港柴灣柴灣道111號高威閣2樓1號(前座) 電話 : 2515 2833

Address : Flat 1 (Front Portion), 2/F, Koway Court, No. 111 Chai Wan Road, Chai Wan, Hong Kong. Phone : 2515 2833

### 出線64強

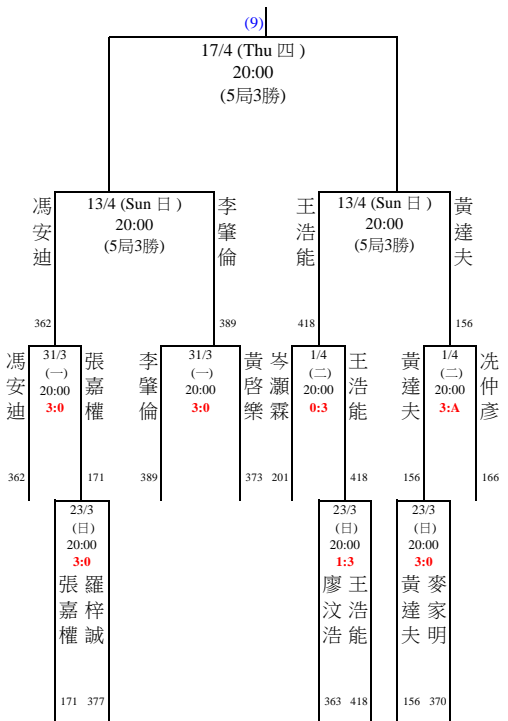

### 出線64強

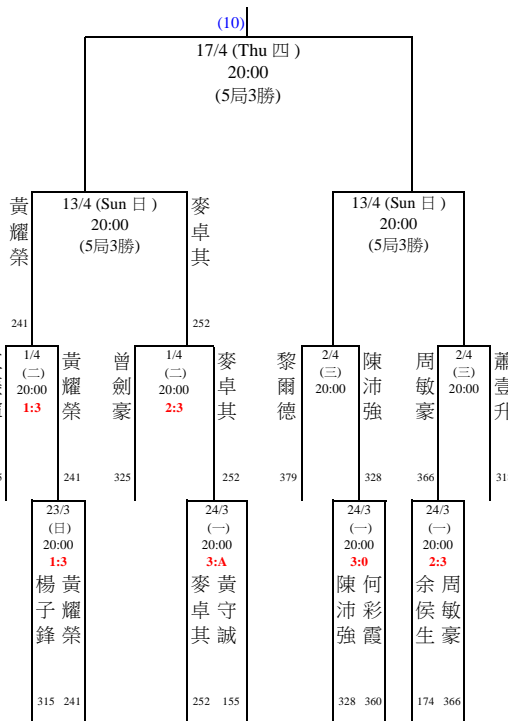

### 出線64強

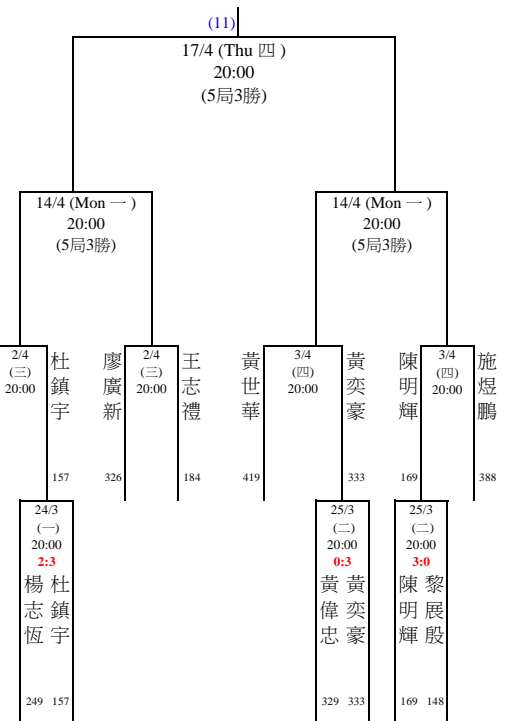

### 出線64強

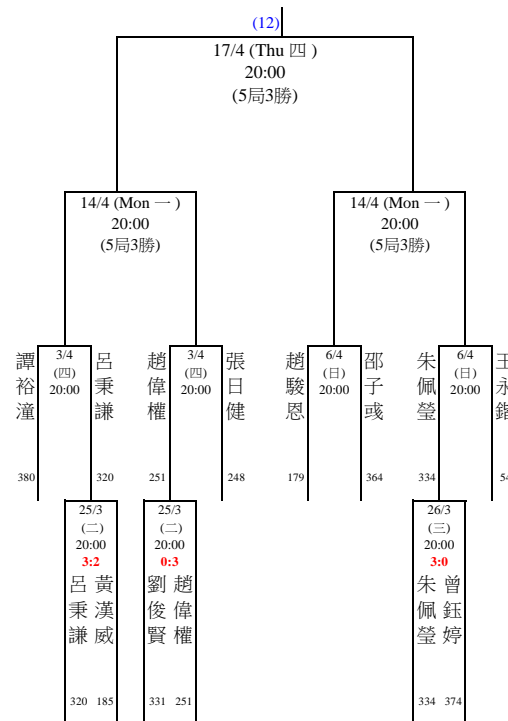

網頁Web-site : <http://www.hkbilliardsports.org.hk/>

#### 註 Remarks :

- 賽事採用單淘汰制：初賽 - 5局3勝；64強至八強及季軍賽 - 7局4勝；四強及決賽 - 9局5勝。  
Knock-Out System: Preliminary - Best of 5 Frames; Last 64 to Quarter Finals, including the 2nd Runner-up Match - Best of 7 Frames; Semi Finals & Final - Best of 9 Frames.
- 參賽者遲於開賽時間到達比賽場地報到則負一局；再遲於指定時間15分鐘到達比賽場地報到作棄權論，報名費概不發還。  
Any player who is late for reporting will lose 1 frame and if late for 15 minutes will lose the Match and entry fee will be forfeited.
- 參賽者必須穿著整齊服裝（長褲、恤衫/T-恤及皮鞋/波鞋；64強至總決賽：長袖純色恤衫、長西褲、背心、煲呔、深色皮鞋及襪），否則不准出賽。  
Player must wear properly (trousers, shirt/T-shirt and leather shoes/ sport shoes). Tournament standard dress is required from Last 64: Long sleeve predominately plain coloured shirts buttoned at the wrist, trousers, waistcoat, bow tie, dark leather shoes and socks must be worn.
- 場館負責登記一棒最高度數記錄。Officials of venue will record the highest break of each match.  
如有任何查詢，請致電中國香港桌球總會有限公司（賽事總監陳順佳先生 電話：9488 4541 總裁判陳榮忠先生 電話：9435 1069）  
Enquiry : HKBSCC (Mr. Jerry Chan - Tournament Director : 9488 4541 Mr. Chan Wing Chung - Chief Referee : 9435 1069)

參加者必須穿著指定服裝，否則不准出賽。

# 2025香港英式桌球公開賽 - 第一站

## Hong Kong Snooker Open Championship 2025 - Event 1

比賽場地 Venue : 名智桌球(柴灣) Ming's Snooker (Chai Wan)

地址 : 香港柴灣柴灣道111號高威閣2樓1號(前座) 電話 : 2515 2833

Address : Flat 1 (Front Portion), 2/F, Koway Court, No. 111 Chai Wan Road, Chai Wan, Hong Kong. Phone : 2515 2833

名智柴灣 4

### 出線64強

### 出線64強

### 出線64強

### 出線64強

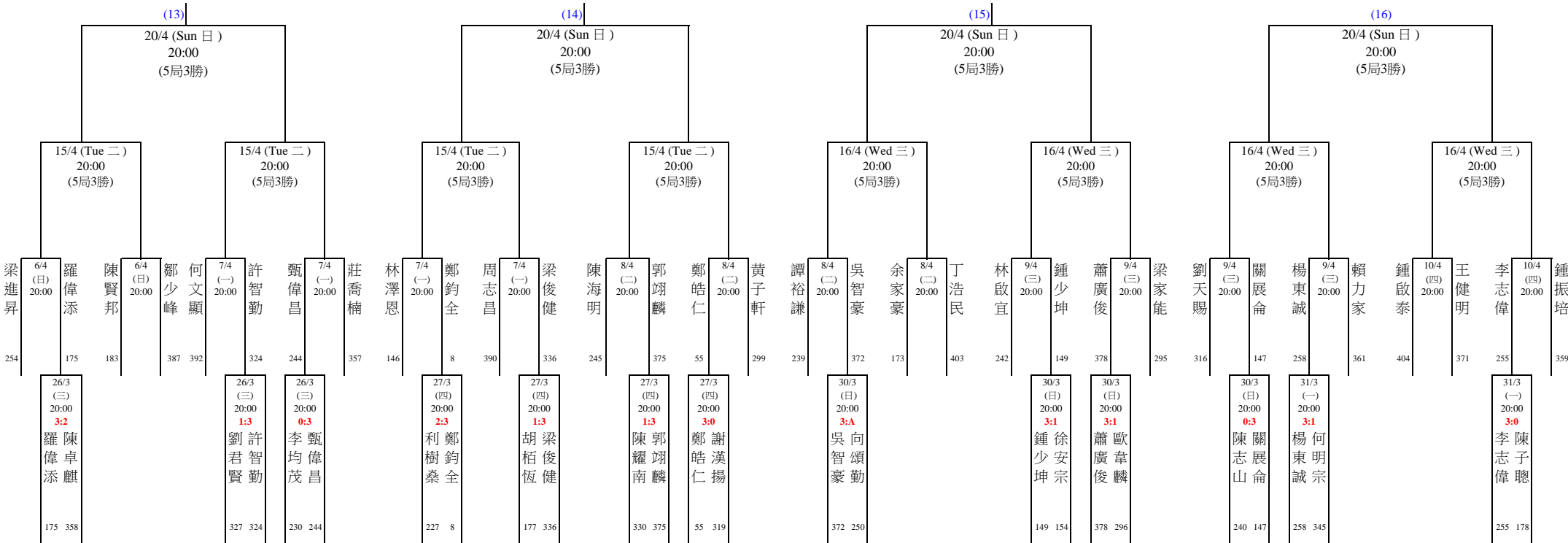

網頁Web-site : <http://www.hkbilliardsports.org.hk/>

**註 Remarks :**

- (1) 賽事採用單淘汰制：初賽 - 5局3勝；64強至八強及季軍賽 - 7局4勝；四強及決賽 - 9局5勝。  
Knock-Out System: Preliminary - Best of 5 Frames; Last 64 to Quarter Finals, including the 2nd Runner-up Match - Best of 7 Frames; Semi Finals & Final - Best of 9 Frames.
  - (2) 參賽者遲於開賽時間到達比賽場地報到則負一局；再遲於指定時間15分鐘到達比賽場地報到作棄權論，報名費概不發還。  
Any player who is late for reporting will lose 1 frame and if late for 15 minutes will lose the Match and entry fee will be forfeited.
  - (3) 參賽者必須穿著整齊服裝（長褲、恤衫/T-恤及皮鞋/波鞋；64強至總決賽：長袖純色恤衫、長西褲、背心、煲呔、深色皮鞋及襪），否則不准出賽。  
Player must wear properly (trousers, shirt/T-shirt and leather shoes/sport shoes). Tournament standard dress is required from Last 64: Long sleeve predominately plain coloured shirts buttoned at the wrist, trousers, waistcoat, bow tie, dark leather shoes and socks must be worn.
  - (4) 場館負責登記一棒最高度數紀錄。Officials of venue will record the highest break of each match.
- 如有任何查詢，請致電中國香港桌球總會有限公司（賽事總監陳順佳先生 電話：9488 4541 總裁判陳榮忠先生 電話：9435 1069）  
Enquiry : HKBSCC (Mr. Jerry Chan - Tournament Director : 9488 4541 Mr. Chan Wing Chung - Chief Referee : 9435 1069)

參加者必須穿著指定服裝，否則不准出賽。

# 2025香港英式桌球公開賽 - 第一站

## Hong Kong Snooker Open Championship 2025 - Event 1

**比賽場地 Venue : 名智桌球(柴灣) Ming's Snooker (Chai Wan)**

地址：香港柴灣柴灣道111號高威閣2樓1號(前座) 電話：2515 2833

Address : Flat 1 (Front Portion), 2/F, Koway Court, No. 111 Chai Wan Road, Chai Wan, Hong Kong. Phone : 2515 2833

名智柴灣 5

出線8強

出線8強

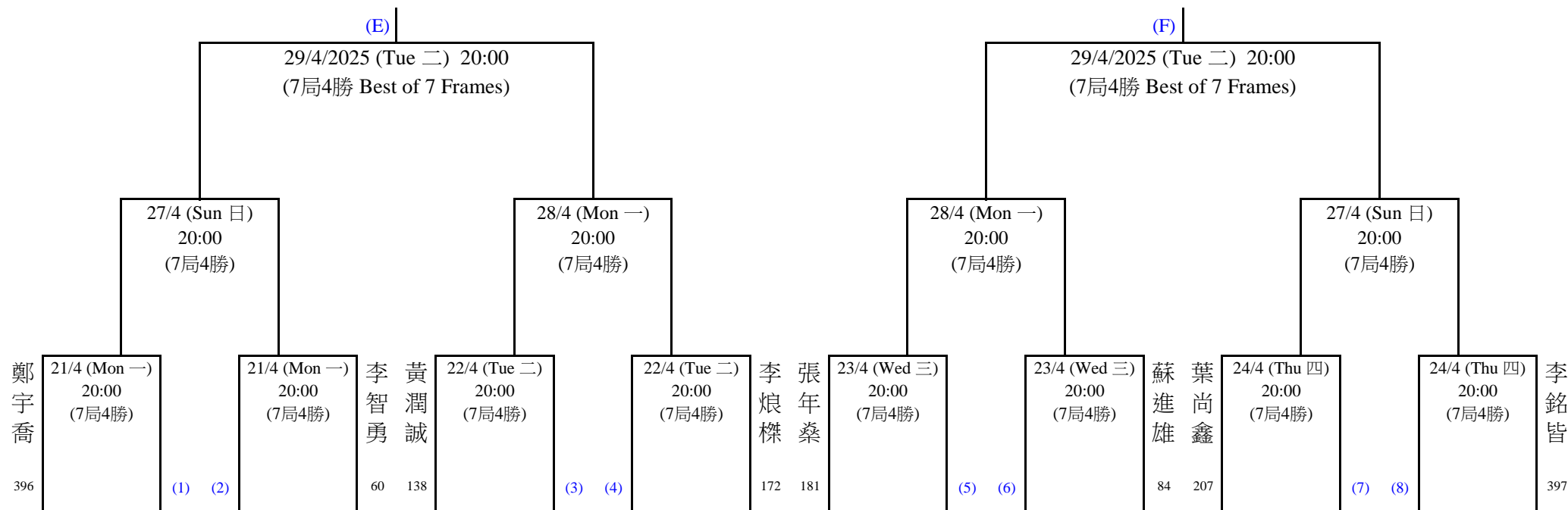

**註 Remarks :**

網頁Web-site : <http://www.hkbilliardsports.org.hk/>

- (1) 賽事採用單淘汰制：初賽 - 5局3勝；64強至八強及季軍賽 - 7局4勝；四強及決賽 - 9局5勝。  
Knock-Out System: Preliminary - Best of 5 Frames; Last 64 to Quarter Finals, including the 2nd Runner-up Match - Best of 7 Frames; Semi Finals & Final - Best of 9 Frames.
- (2) 參賽者遲於開賽時間到達比賽場館報到則負一局；再遲於指定時間15分鐘到達比賽場館報到作棄權論，報名費概不發還。  
Any player who is late for reporting will lose 1 frame and if late for 15 minutes will lose the Match and entry fee will be forfeited.
- (3) 參賽者必須穿著整齊服裝（長褲、恤衫/T-恤及皮鞋/波鞋；64強至總決賽：長袖純色恤衫、長西褲、背心、煲吹、深色皮鞋及襪），否則不准出賽。  
Player must wear properly (trousers, shirt/T-shirt and leather shoes/ sport shoes). Tournament standard dress is required from Last 64: Long sleeve predominately plain coloured shirts buttoned at the wrist, trousers, waistcoat, bow tie, dark leather shoes and socks must be worn.
- (4) 場館負責登記一棒最高度數記錄。Officials of venue will record the highest break of each match.

參加者必須穿著  
指定服裝，否則  
不准出賽。

如有任何查詢，請致電香港桌球總會（賽事總監陳順佳先生 電話：9488 4541 總裁判陳榮忠先生 電話：9435 1069）  
Enquiry : HKBSCC (Mr. Jerry Chan - Tournament Director : 9488 4541 Mr. Chan Wing Chung - Chief Referee : 9435 1069)

# 2025香港英式桌球公開賽 - 第一站

## Hong Kong Snooker Open Championship 2025 - Event 1

**比賽場地 Venue : 名智桌球(柴灣) Ming's Snooker (Chai Wan)**

名智柴灣 6

地址：香港柴灣柴灣道111號高威閣2樓1號(前座) 電話：2515 2833

Address : Flat 1 (Front Portion), 2/F, Koway Court, No. 111 Chai Wan Road, Chai Wan, Hong Kong. Phone : 2515 2833

出線8強

出線8強

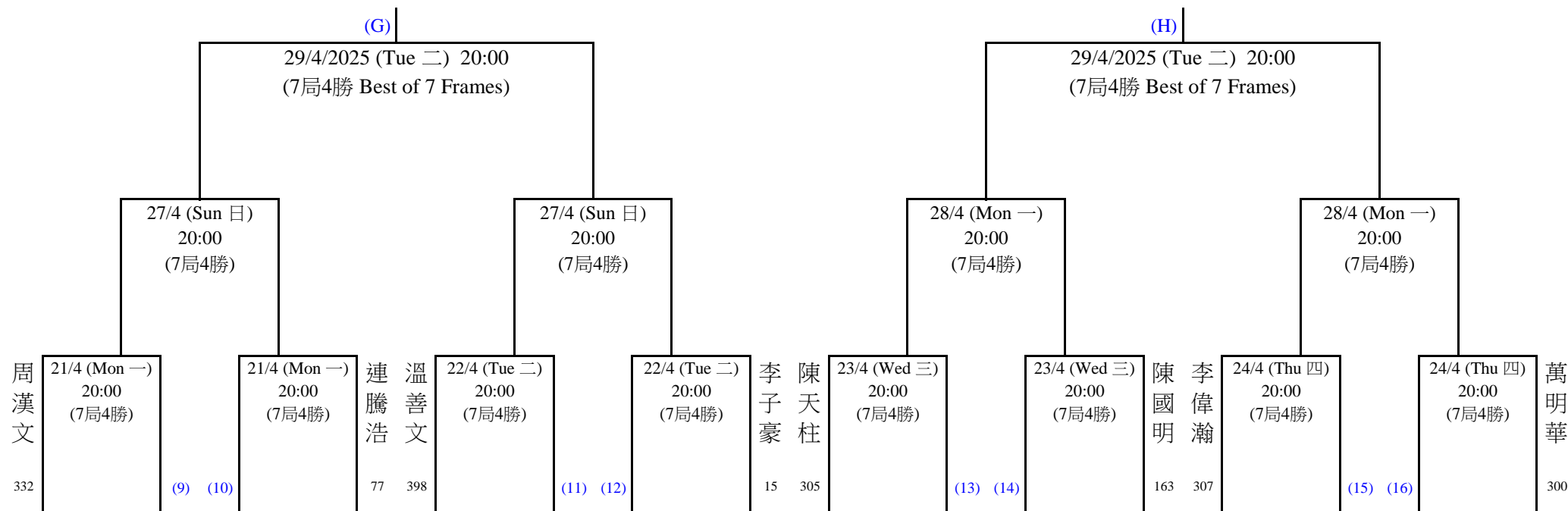

**註 Remarks :**

網頁Web-site : <http://www.hkbilliardsports.org.hk/>

- (1) 賽事採用單淘汰制：初賽 - 5局3勝；64強至八強及季軍賽 - 7局4勝；四強及決賽 - 9局5勝。  
Knock-Out System: Preliminary - Best of 5 Frames; Last 64 to Quarter Finals, including the 2nd Runner-up Match - Best of 7 Frames; Semi Finals & Final - Best of 9 Frames.
- (2) 參賽者遲於開賽時間到達比賽場館報到則負一局；再遲於指定時間15分鐘到達比賽場館報到作棄權論，報名費概不發還。  
Any player who is late for reporting will lose 1 frame and if late for 15 minutes will lose the Match and entry fee will be forfeited.
- (3) 參賽者必須穿著整齊服裝（長褲、恤衫/T-恤及皮鞋/波鞋；64強至總決賽：長袖純色恤衫、長西褲、背心、煲吹、深色皮鞋及襪），否則不准出賽。  
Player must wear properly (trousers, shirt/T-shirt and leather shoes/ sport shoes). Tournament standard dress is required from Last 64: Long sleeve predominately plain coloured shirts buttoned at the wrist, trousers, waistcoat, bow tie, dark leather shoes and socks must be worn.
- (4) 場館負責登記一棒最高度數記錄。Officials of venue will record the highest break of each match.

如有任何查詢，請致電香港桌球總會（賽事總監陳順佳先生 電話：9488 4541 總裁判陳榮忠先生 電話：9435 1069）

Enquiry : HKBSCC (Mr. Jerry Chan - Tournament Director : 9488 4541 Mr. Chan Wing Chung - Chief Referee : 9435 1069)

參加者必須穿著  
指定服裝，否則  
不准出賽。

# 2025香港英式桌球公開賽 - 第一站

## Hong Kong Snooker Open Championship 2025 - Event 1

**比賽場地 Venue : 名智桌球(觀塘) Ming's Snooker (Kwun Tong)**

地址：九龍觀塘興業街4號THE WAVE 5樓      電話：3615 8601

Address : 5/F, The Wave, No. 4 Hing Yip Street, Kwun Tong, Kolwoon.      Phone : 3615 8601

### 冠軍賽 Finals

### 季軍賽

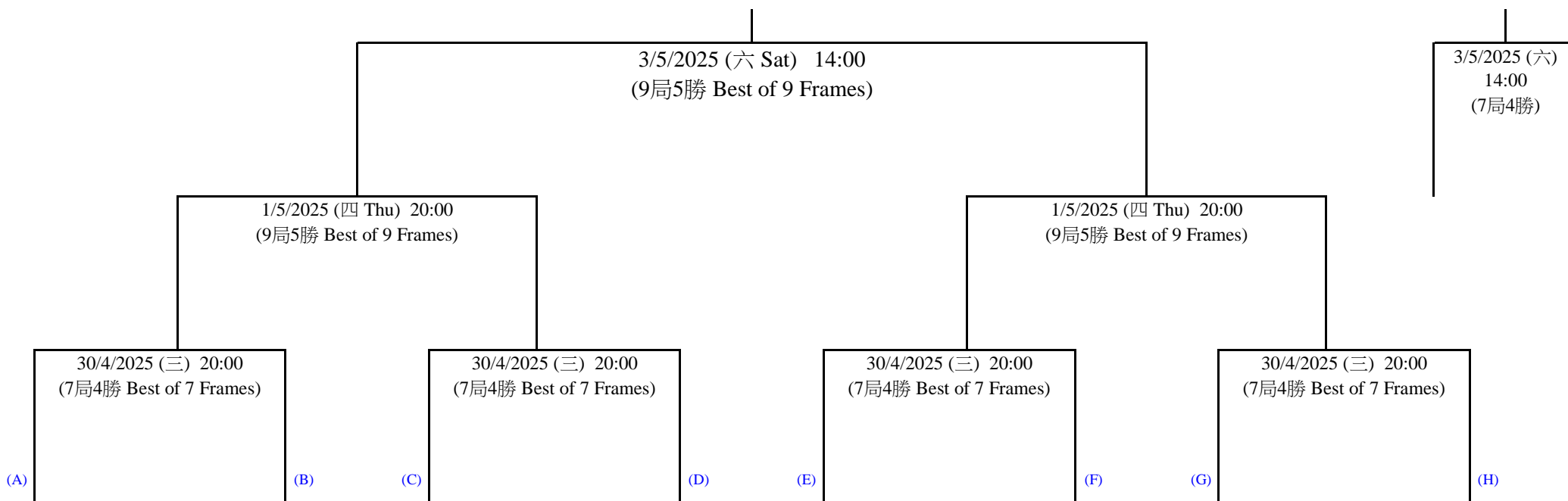

網頁Web-site : <http://www.hkbilliardsports.org.hk/>

**註 Remarks :**

- (1) 賽事採用單淘汰制：64強至八強及季軍賽 - 7局4勝；四強及決賽 - 9局5勝。Knock-Out System: Last 64 to Quarter Finals, including the 2nd Runner-up Match - Best of 7 Frames; Semi Final & Final - Best of 9 Frames.
- (2) 參賽者遲於開賽時間到達比賽場館報到則負一局；再遲於指定時間15分鐘到達比賽場館報到作棄權論，報名費概不發還。  
Any player who is late for reporting will lose 1 frame and if late for 15 minutes will lose the Match and entry fee will be forfeited.
- (3) 參賽者必須穿著傳統比賽服裝（長袖純色恤衫、長西褲、背心、煲呔、深色皮鞋及襪），否則不准出賽。  
Tournament standard dress is required : Long sleeve predominately plain coloured shirts buttoned at the wrist, trousers, waistcoat, bow tie, dark leather shoes and socks must be worn.
- (4) 場館負責登記一棒最高度數記錄。Officials of venue will record the highest break of each match.

如有任何查詢，請致中國電香港桌球總會有限公司（賽事總監陳順佳先生 電話：9488 4541 總裁判陳榮忠先生 電話：9435 1069）

Enquiry : HKBSCC (Mr. Jerry Chan - Tournament Director : 9488 4541 Mr. Chan Wing Chung - Chief Referee : 9435 1069)

